



DATOS MOTOR

POTENCIA	10HP
REVOLUCIONES	1760
FRECUENCIA	60HZ
TORQUE MOTOR NOMINAL	40,7
CARCASA (PAM)	132(B5)
TIPO BRIDA	FF-265
EFICIENCIA MOTOR	IE 2

DATOS REDUCTOR

REFERENCIA	550029
TIPO	ORTOGONAL
MODELO	FCNDK
MATERIAL	HIERRO
CARCASA	150
RELACION DE TRANSMISION i:	30
VELOCIDAD SALIDA	58,67
TORQUE MAXIMO	1200
TORQUE OPERACIÓN	1013
FACTOR DE SERVICIO	1,2

PLANOS REDUCTOR

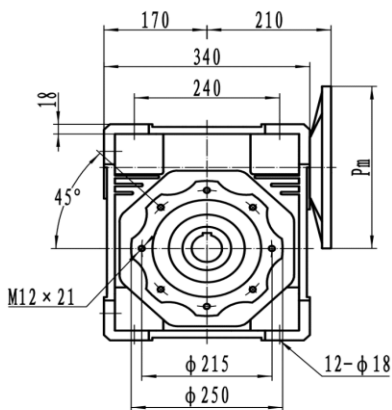

FCN 150

Input shaft hole Output shaft hole

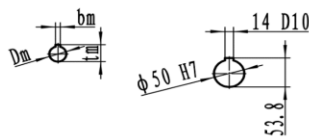

	Pm	Dm	bm	tm
100/112B5	250	28	8	31.3
132B5	300	38	10	41.3
160B5	350	42	12	45.3

